

2510 L WATER TANK

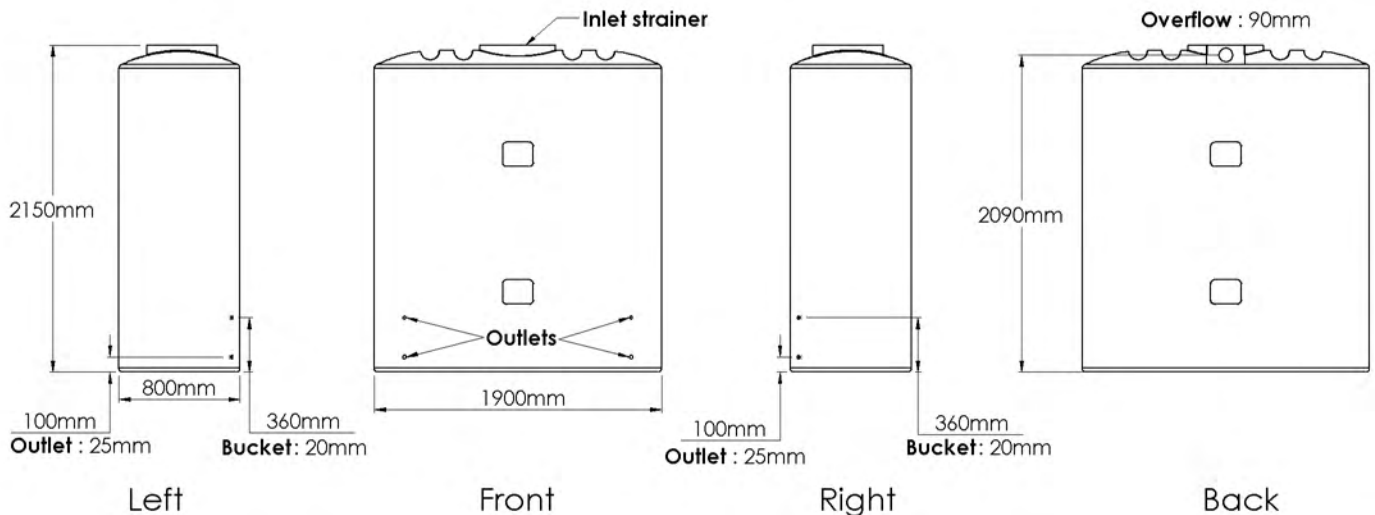

Standard Fitout

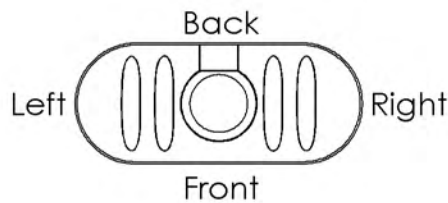

Supplied: Ball valve, overflow strainer

Custom Fitout?

Please visit the Tank Range page at: melro.com.au
Click on the *Custom Tank* link below your tank
Print and complete the form for your tank supplier